



PRO

design Roberto Fiorato



Pro is also available
in emergency models
(Proplat 25 EM/1P).

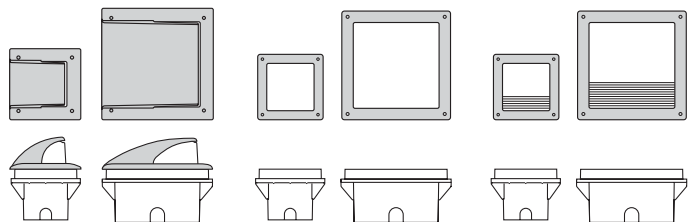

A range of wall recessed and in-ground luminaires in a variety of sizes and lamp options. Frame and cover screens in die-cast aluminium or stainless steel, with frosted or painted glass covers.

Provisa is offered in two sizes and is available as Provisa Wall, wall semi-recessed or Provisa Floor, in-ground semi-recessed.

Profil is designed for in-ground recessing and has a stainless steel frame for flush mounting, it is offered in two sizes with diffused or asymmetrical light distribution.

Protech is offered in three sizes for wall recessed installations. The lamp chamber and gear compartment are hidden behind glass cover and ensures glare free lighting, whilst protecting the lamp and access to electrical parts. A sturdy product that is simple to maintain and clean.

Proplat wall recessed fittings are supplied with a range of lamp versions including LED and emergency versions.

Progrill is supplied with a vandal resistant anti-glare cover grill that also directs the light source downwards.

The Pro range of discreet high performance fittings are the ideal solution for commercial and domestic accent lighting, display and public entertainment areas, and pedestrian walkways.

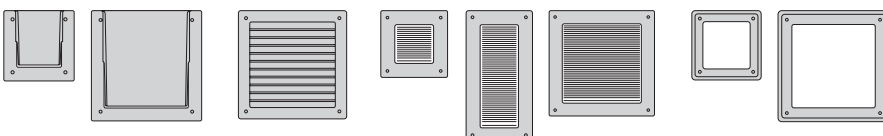



UNDERGROUND - TORINO (ITALY)



Profil and Proplat "L" versions include a printed board with 25 high efficiency LED.

The screen used in Pro Visa partially limits light emission.



The screen used in Pro Visa partially limits light emission.

The grill shaped screen on the Pro Grill model reduces glare and directs the light beam towards the ground.



The Profil S models emit a symmetrical beam through frosted glass.



The Profil A models emit an asymmetrical beam through partially screened transparent glass.

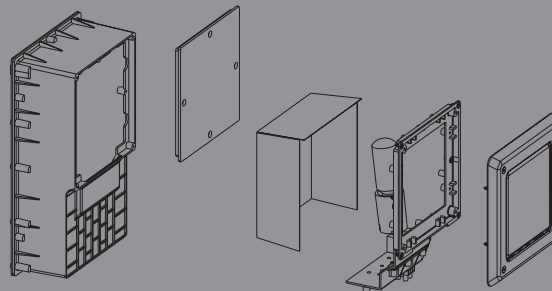
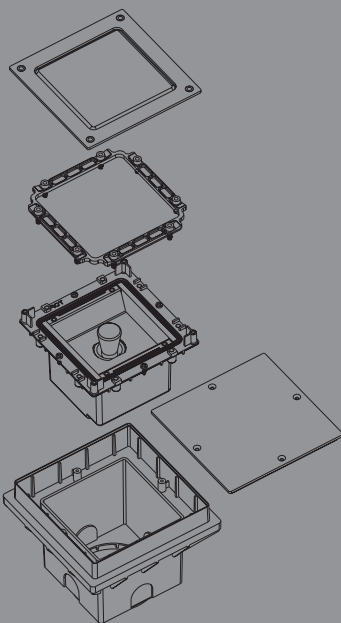

The luminaires are made up of a recessed fixing kit body and a gear tray/lampholder assembly. The recessed fixing kit body is equipped with a protective lid, to remove after the being set in the wall to insert the cabled structure.





PROFIL

LUMINAIRE THAT REQUIRES A FIXING KIT FOR INSTALLATION



Δ 1100 kg

Flush recessed inground and wall/ mount luminaire including:

- die-cast non corroding polished aluminium housing
- clear glass diffuser with half screen for asymmetric (A) versions, satin glass diffuser for symmetric (S) versions
- stainless steel frame and locking screws
- polymer gasket
- V2 rated self-extinguishing technopolymer recessed fixing to be ordered separately
- the recessed fixing kit is supplied complete with a protective cover allowing all masonry work necessary to a proper installation
- 2,5 m of HO7RN-F, 3x1,5mm² neoprene cable, integral with the fitting and non removable. Connection with mains supply must be done in a watertight box or with resin-filled wire connectors
- "L" versions include a printed board with 25 high efficiency LED and 230V safety transformer
- LED versions available in white and blue

An additional gasket is used to avoid water stagnation in between housing and recessed fixing kit. It is advisable to avoid that cables either act as siphon or draw water from farther unprotected connection boxes.

PROFIL 15A
PROFIL 15S

	E14	max 1x25w IBS
--	-----	---------------

PROFIL 25A

	E27	max 1x60w IAA
	R7s	max 1x60w HDG
	Gx24d-3	1x26w FSM

PROFIL 25S

	E27	max 1x60w IAA
	R7s	max 1x60w HDG
	Gx24q-3	1x26w FSM

PROFIL 15L

	n. 25 led x 2w
--	----------------

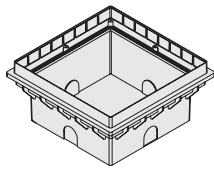

description	colour	code
Recessed fixing kit 15		009371
Recessed fixing kit 25		009372

lampholder	w	ILCOS	colour	class	IP	Kelvin	Cos φ ≥ 0,9	EEL	code	notes
PROFIL 15A										
E14	max 1x25w	IBS	SS1	I	67	•			IK09 10J xx7	008285
PROFIL 25A										
E27	max 1x60w	IAA	SS1	I	67	•			IK09 10J xx7	008289
Halogen										
R7S	max 1x60w	HDG	SS1	I	67	•			IK09 10J xx7	008290
Fluorescent - electronic ballast 220/240V 50/60Hz										
GX24q-2	1x18w	FSM	SS1	I	67	•	2700		IK09 10J xx7	A2÷A3 058292

If information about Kelvin degrees is provided, this means that the light bulb is included.

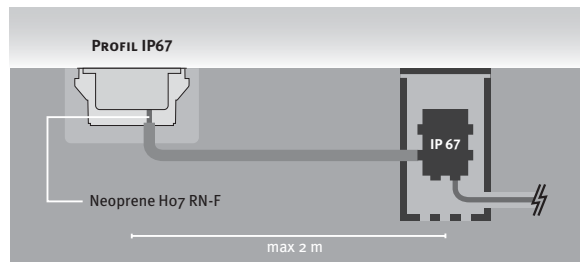

SS1	SS1+WHL	SS1+BLL
-----	---------	---------

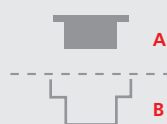

COMPLETE UNIT
1A+1B = please order 2 codes

COMPONENTS

A luminaire
B recessed fixing kit

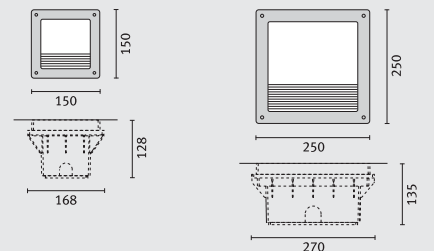



lampholder w ILCOS colour class IP Kelvin \uparrow \downarrow $\geq 0,9$ EEl code notes

PROFIL 15S

E14	max 1x25w	IBS	SS1	I	67	•	IK09 10J xx7	008287
-----	-----------	-----	-----	---	----	---	--------------	--------

PROFIL 15L

LED - voltage 220/240V 50/60Hz

n. 25 led x 2w	SS1+WHL	I	67	•	6000	IK09 10J xx7	008324
n. 25 led x 2w	SS1+BLL	I	67	•		IK09 10J xx7	008325

PROFIL 25S

E27	max 1x60w	IAA	SS1	I	67	•	IK09 10J xx7	008293
-----	-----------	-----	-----	---	----	---	--------------	--------

Fluorescent - electronic ballast 220/240V 50/60Hz

GX24q-3	1x26w	FSM	SS1	I	67	•	2700	IK09 10J xx7	•	A2	058296
---------	-------	-----	-----	---	----	---	------	--------------	---	----	--------

If information about Kelvin degrees is provided, this means that the light bulb is included.

