

SHIELD

design Roberto Fiorato



Wall mounted indoor/outdoor luminaire with up/down light emission, for accent lighting. The light beam changes depending on the type of lamps used. The screen in extruded aluminium is available in four different finishes and can be customized upon



request with decorations, monograms, logos or signs and symbols. SHIELD is a very versatile fixture, with impressive visual impact, particularly suitable for large hotels or public buildings where it is necessary to create ambient lighting.



SHIELD is also available
in an emergency model
(SHIELD EM/3P).

SHIELD

SHIELD

	E27	max 2x60 W IBP
	E27	max 1x75 W IAA
	G24q-3	1x26 W FSQ

SHIELD EM/3P

	G24q-2	1x18 W FSQ
--	--------	------------

Wall luminaire for indoor and outdoor use, for indirect lighting, comprising:

- Die-cast aluminium housing
- Extruded aluminium cover
- Glass diffuser
- Stainless steel screws

Customised covers (with logos, letters, etc.) are available upon request



lampholder	W	ILCOS	colour	class	IP			Kelvin		Cos φ	EEL	code	notes
------------	---	-------	--------	-------	----	---	---	--------	---	-------	-----	------	-------

SHIELD

E27	max 2x60 W	IBP		I	65	•	•					008461	
E27	max 1x75 W	IAA		I	65	•	•					008460	

Fluorescent - electronic ballast 220/240 V 50/60 Hz

G24q-3	1x26 W	FSQ		I	65	•					• A2	058466	
--------	--------	-----	--	---	----	---	--	--	--	--	------	--------	--

SHIELD EM/3P

Emergency - electronic ballast

G24q-2	1x18 W	FSQ		I	65	•						A2÷A3	300775	
--------	--------	-----	--	---	----	---	--	--	--	--	--	-------	--------	---

If information about Kelvin degrees is provided, this means that the lamp is included.

GR2

TN1

BZ1





COMPLETE UNIT

1A+1B = please order 2 codes

COMPONENTS

- A housing
- B cover

1  emergency - 1 hour
 2  emergency - 2 hours
 3  emergency - 3 hours

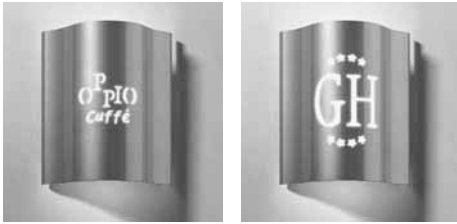

The maximum size of the customizable area is indicated in the drawing.

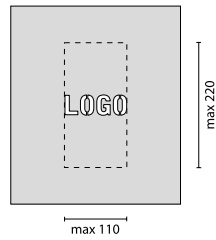
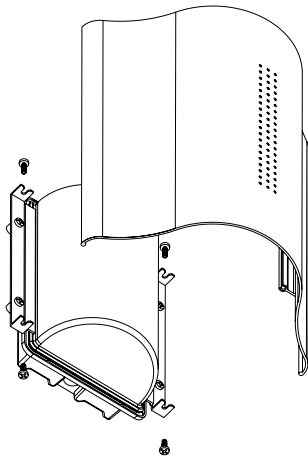

description	colour	DT	code
Cover SHIELD Split	GR2	IK08 5J xx5	008474
Cover SHIELD Split	TN1	IK08 5J xx5	008475
Cover SHIELD Split	BZ1	IK08 5J xx5	008477
Cover SHIELD Dot	GR2	IK08 5J xx5	008468
Cover SHIELD Dot	TN1	IK08 5J xx5	008469
Cover SHIELD Dot	BZ1	IK08 5J xx5	008471

