

LED

STEEL



A range of in-ground recessed fittings with a variety of cover housings manufactured from investment cast pure stainless steel, self-extinguishing technopolymer body and clear toughened glass cover.

The stainless steel cover housings are not painted and have an inalterable surface that resists wear and tear.

Round models are available with asymmetrical reflector (A), circular reflector (C) and with the light directed along the ground in three different combinations. These models use fluorescent and discharge light sources, and are indicated for lighting architectural details and walkways.

The Mini Quadro and Mini Duplex models – suitable for accent lighting in gardens, and around monuments and perimeter walls – are designed for LEDs with a beam angle of 6°, 45° and 120°.

The Visa luminaires use LEDs with light directed flush with the ground in one or two directions. They are suitable for defining outdoor pedestrian walkways.

All Steel fixtures are designed for individual or continuous power supply.

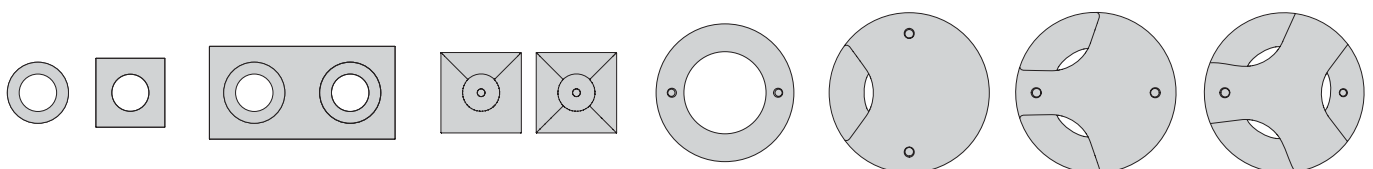
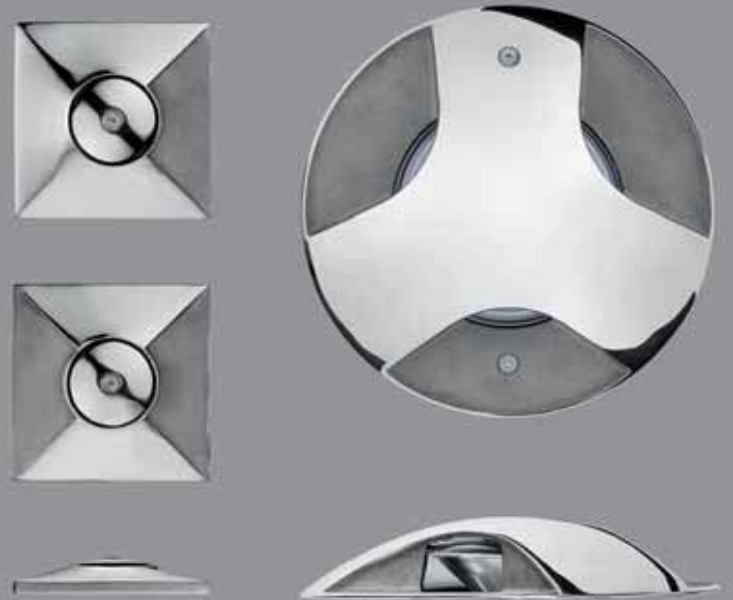

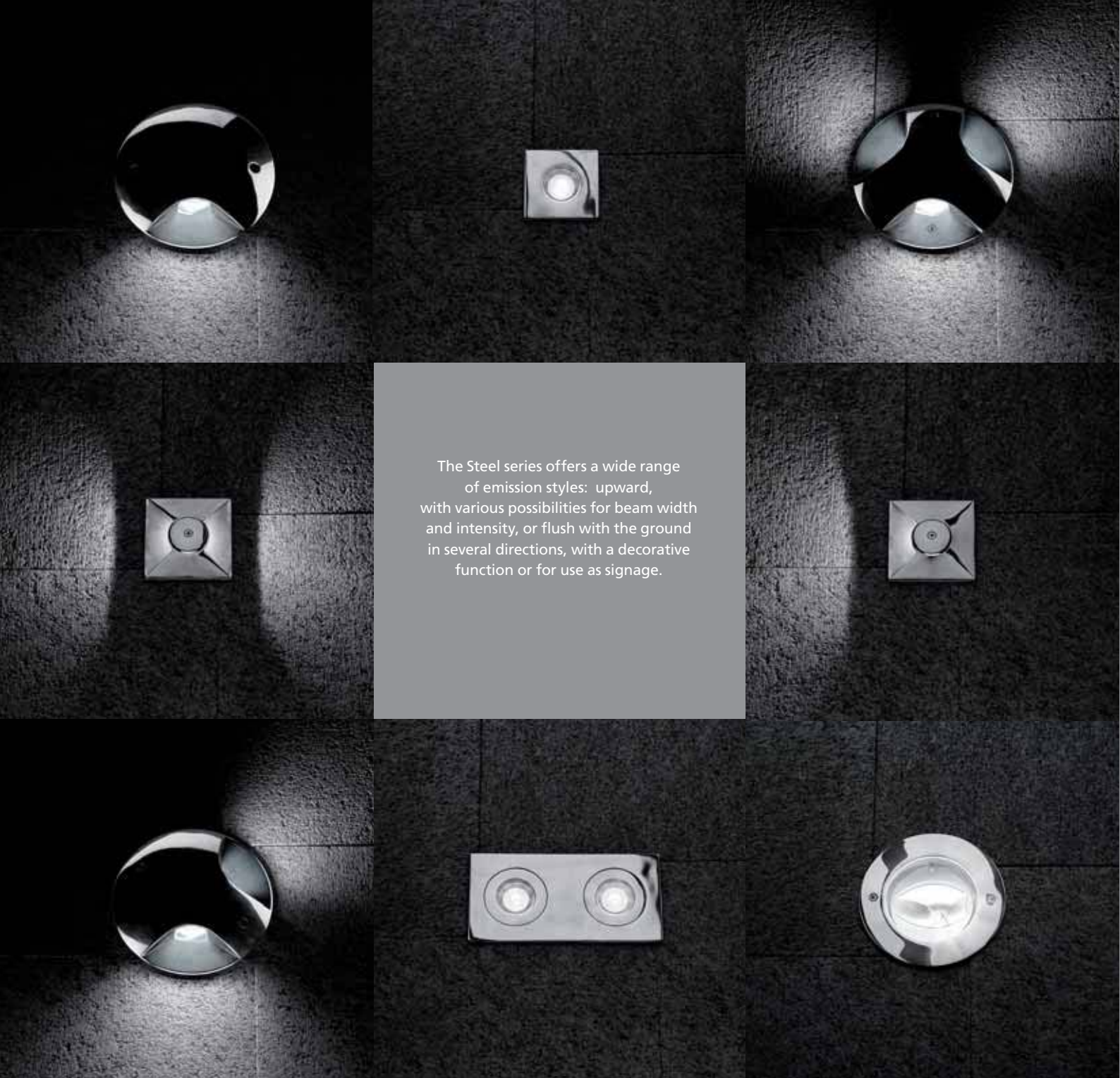

The Steel series offers a wide range of emission styles: upward, with various possibilities for beam width and intensity, or flush with the ground in several directions, with a decorative function or for use as signage.



Steel luminaires are designed to prevent humidity and condensation inside the luminaire bodies under particular thermal conditions. This safeguards the wiring, which is clearly an advantage as far as luminaire safety and reliability are concerned.

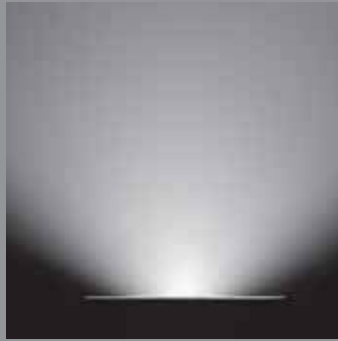

STEEL ROUND (wide beam)



STEEL ROUND/A (asymmetrical)



STEEL ROUND/C (concentrated)



STEEL ROUND LED NB 8° (concentrated)

Steel Round can use five different types of light emission styles.



STEEL ROUND LED WALL WASHER 10°X45° (elliptical - lower axis)



STEEL ROUND LED WALL WASHER 10°X45° (elliptical - greater axis)

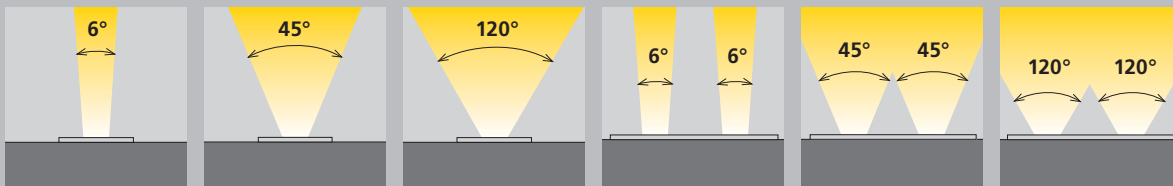

The Mini Quadro, Mini Round and Mini Duplex models are designed for LEDs with a beam angle of 6°, 45° and 120°.

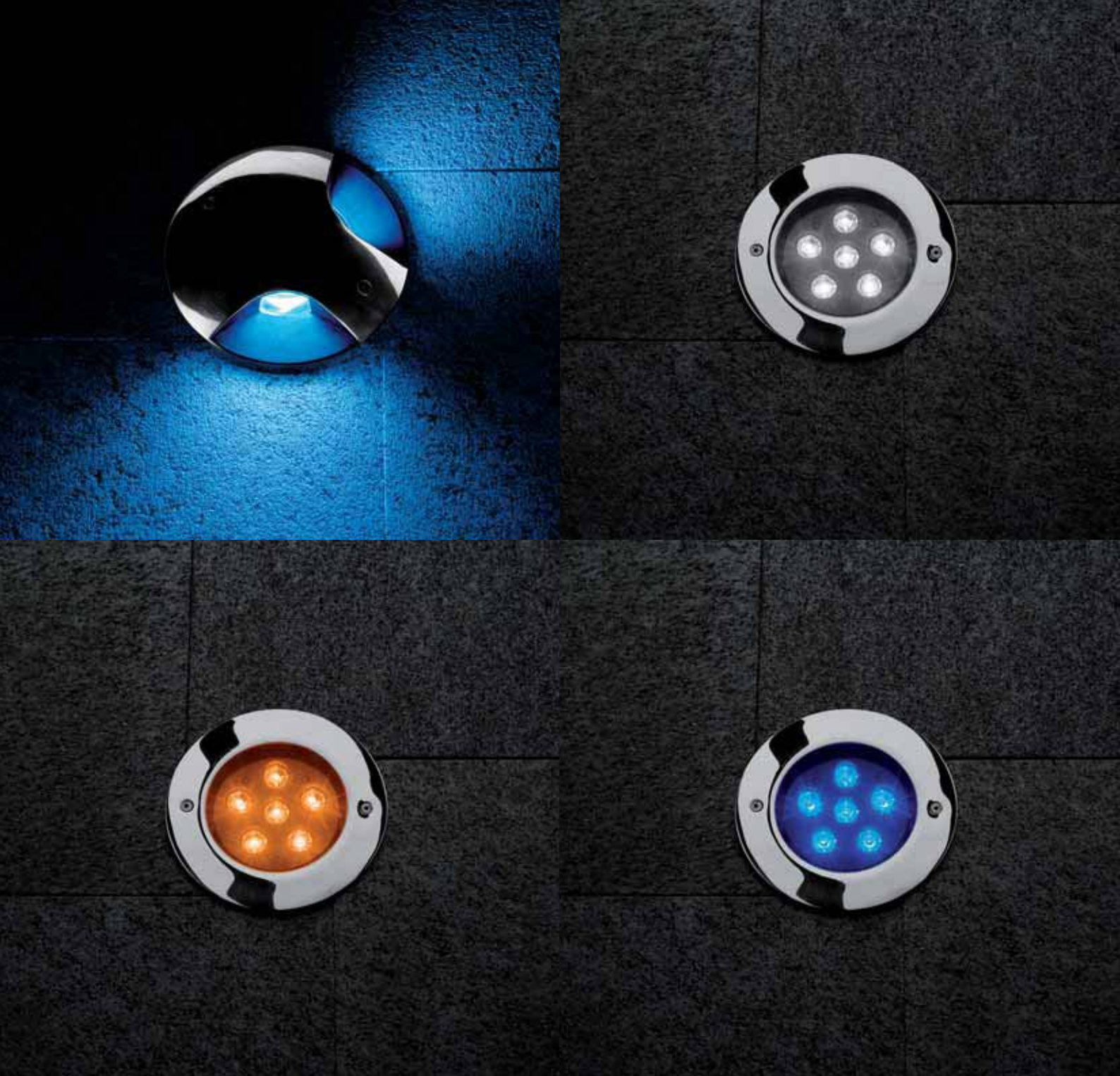

Steel Round LED is available in white, blu, and amber LEDs.
Steel Round LED 90°, 180° and 360° are available in white and blue LEDs.



Steel Mini Quadro, Steel Mini Round, Steel Mini Duplex and Steel Mini Visa are designed exclusively for LEDs, also high power models, in white and blue (with other colours available upon request).



All temperatures in °C
(cover and diffuser)

Steel Round

B15D	1x50w HMGS	175°
E27	1x50w HAG	175°
GU5,3	1x50w HRG	175°
GZ10	1x50w HRG	175°
GX10	1x20w CMH-MR16	80°

Steel Round/C

E27	1x8w FBT	50°
G24q-1	1x10w FSQ	52°
PGJ5	1x20w CDM-TM	85°
G8,5	1x20w MT	80°

Steel Round/A

PGJ5	1x20w CDM-TM	83°
G8,5	1x20w MT	78°

Steel Round 90°

G8,5	1x20w MT	58°
------	----------	-----

Steel Round 180°

G8,5	1x20w MT	58°
------	----------	-----

Steel Round 360°

G8,5	1x20w MT	56°
------	----------	-----

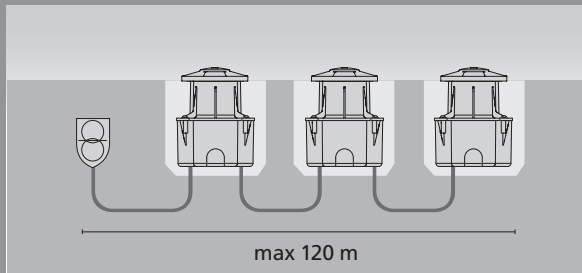

All Steel fixtures are designed for individual or continuous power supply.

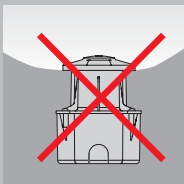

Never install the luminaire below grade.



STEEL MINI QUADRO

LUMINAIRE THAT REQUIRES A FIXING KIT FOR INSTALLATION

	n. 1 led 6°x3,2w
	n. 1 led 45°x3,2w
	n. 9 led 120°x1,5w

Series of class III inground luminaires comprising of:

- Housing in self-extinguishing techno-polymer
- Clear glass cover
- Sand cast stainless steel frame
- Silicone seal
- Stainless steel screws
- Each luminaire is supplied with two IP68 cable clamps allowing through power connection
- Steel Mini Quadro is available with 9 LEDs with a 12V direct current supply, or with 1 power LED with a stabilised 700 mA direct current supply, to be exclusively connected in line, without interrupting the secondary circuit
- RGB power versions available upon request
- Steel Mini Quadro is preset for individual or continuous line power supply (see diagram)
- The luminaire comprises a body with lamps and the appropriate recessing kit. (see accessories)



lampholder	w	ILCOS	colour	class	IP	Kelvin	$\text{Cos } \phi \geq 0,9$	EEL	code	notes
------------	---	-------	--------	-------	----	--------	-----------------------------	-----	------	-------

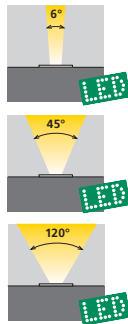

STEEL MINI QUADRO

Power LED

n. 1 led 6°x3,2w	SS1+WHL	III	67	• 6500	IK07 2J xx5	001162
n. 1 led 6°x3,2w	SS1+BLL	III	67	•	IK07 2J xx5	001163
n. 1 led 45°x3,2w	SS1+WHL	III	67	• 6500	IK07 2J xx5	001164
n. 1 led 45°x3,2w	SS1+BLL	III	67	•	IK07 2J xx5	001165

LED - voltage

n. 9 led 120°x1,5w	SS1+WHL	III	67	• 6500	IK07 2J xx5	001160
n. 9 led 120°x1,5w	SS1+BLL	III	67	•	IK07 2J xx5	001161

If information about Kelvin degrees is provided, this means that the light bulb is included.

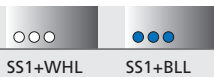

Steel Mini Quadro	L	A	
9 led 12V - 1,5w	max 120 m	max 6	12V DC
1 led 3,2w	max 100 m	max 5	700 mA DC

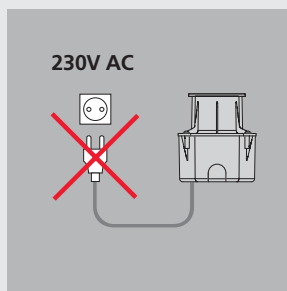
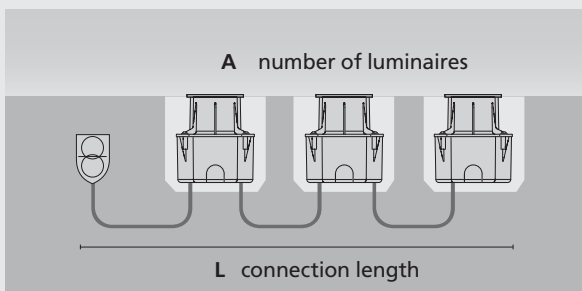
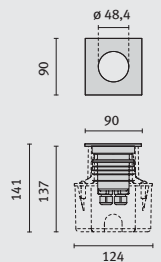
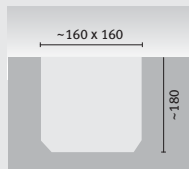

STEEL MINI

ACCESSORIES

- Single recessed fixing kit (for Steel Mini Quadro and Steel Mini Visa) and double recessed fixing kit (for Steel Mini Duplex) in self-extinguishing techno-polymer
- Box IP67, for recessed installation, with 9W and 40W electronic LED converter, stabilized output current 12V DC, to be installed in a protected area (see instructions)
- Box IP67, for recessed installation, with 17W electronic LED converter, stabilized output current 700mA DC, to be installed in a protected area (see instructions)
- Box IP67, for recessed instalment, with 10W electronic LED converter, constant output current 350 mA DC, to be installed in a protected area (see instructions)

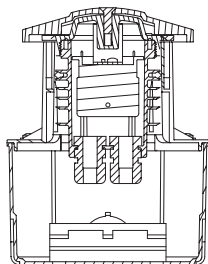

description	colour	code
Single recessed fixing kit		000350
Double recessed fixing kit		000351
IP67 driver kit with current 220/240V 350mA 10w		000354
IP67 driver kit with current 220/240V 700mA 2/18w		000353
IP67 driver kit with voltage 220/240V 12V DC 2.2/6,6w		000352

COMPLETE UNIT
 1A+1B = please order 2 codes
 COMPONENTS
A gear body
B recessed fixing kit

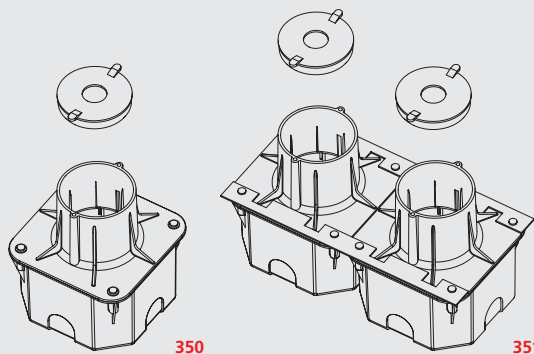
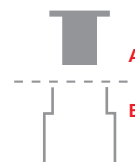

352
353
354

