

TYCO 10

design Silvia Paola Pennacchio



TYCO die cast aluminium IP66 spot lights for halogen, dichroic and LED lamps suitable for indoor and outdoor applications. A compact and contemporary designed fitting manufactured from high quality materials and precision finishing. Ideal for highlighting and architectural feature / effect lighting, museums, sculptures, galleries, retail, showrooms, gardens and parks etc. TYCO are available in two sizes:

- Tyco 10, suitable for lamp types (maximum); 50W halogen, 50W dichroic and 3x1W LED.
- Tyco 20, suitable for lamp types (maximum); 150W metal halide and 75W halogen.

- Body, frame and control gear box in chromate pre treated corrosion resistant die cast painted aluminium grey or matt black.
- Toughened safety glass.
- Reflector in high purity 99.85% aluminium anodized and polished.
- Gasket locating ring in technopolymer, resistant to very high temperatures.
- Silicone gaskets
- Internal Teflon / silicone sheathed cables.
- Cable entry Ø7-10mm-2x1-1.5mm²
- Stainless steel external screws.

TYCO 10



TYCO 12



TYCO 14



TYCO 15



TYCO 13

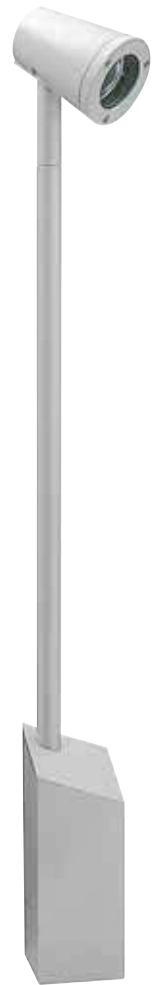

Tyco offers a solution to a variety of applications with the following versions:

- Tyco 10
- Tyco 12
- Tyco 13
- Tyco 14
- Tyco 15

Tyco LED versions are non-UV transmitting and minimum heat radiated fittings making them particularly useful for areas sensitive to UV and heat e.g. galleries, paintings, artwork, museums, ancient artefacts etc.

Tyco 10/51 - 12/51 - 14/51 - 13/51 models are complete with self adjustable lamp positioning for wide to narrow beam light distributions.



TYCO 11 die cast aluminium spotlight fittings suitable for indoor and outdoor applications, designed for use with new generation compact metal halide lamps; CDM-TM 20W/CMH MR16 20W. A contemporary designed fitting manufactured from high quality materials, suitable for a variety of applications as accent and feature lighting; for buildings façades, highlighting architectural features in museums, churches, galleries or effect lighting in retail and showrooms etc.

TYCO 11 is available in the following versions:

- TYCO 11 MT for floor or wall mounted
- TYCO 11 SLIM FL (floor) floor mounted only.
- TYCO 11 SLIM WL (wall) wall mounted only.
- TYCO 11 RM + BOX TYCO 11 RM MT with remote gear box.

Ideal for applications that require gear box to be hidden discreetly, gear box to be ordered as a separate item in addition to spotlight fitting.

- Fitting constructed from corrosion resistant die-cast and extruded aluminium finished polyester powder coated or MATT BLACK.
 - 5mm toughened safety glass.
 - High performance reflectors, where utilised, in high purity (99.85%) aluminium anodised and polished.
 - Anti-ageing silicon gaskets
 - Teflon insulated cables with silicon sleeving.
 - Automatic isolating terminal.
 - Rubber grommet for cables diam.7-10mm - 2x1,5 mm²
 - Stainless steel external fixings.
- Accessories to meet the most varied installation requirements.

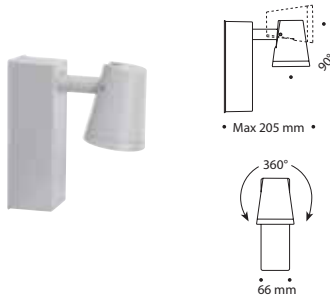

TYCO 11/20 MT

Lampholder	W	Ilcos	*K	Optic	Colour	Class	Wiring	EEL =	Cosp ≥ 0,9	Code	Notes
PGJ5	20	MC		C	81	I	ETRC			04023881	
PGJ5	20	MC		C	94	I	ETRC			04023994	
PGJ5	20	MC		C	96	I	ETRC			04024096	

TYCO 11/21 MT

Lampholder	W	Ilcos	*K	Optic	Colour	Class	Wiring	EEL =	Cosp ≥ 0,9	Code	Notes
GX10	20	MR16			81	I	ETRC			04025181	
GX10	20	MR16			94	I	ETRC			04025294	
GX10	20	MR16			96	I	ETRC			04025396	

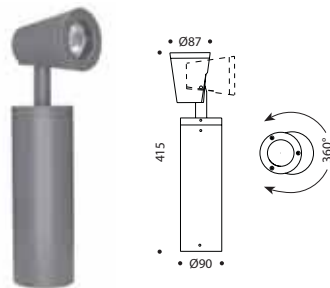

TYCO 11/20 SLIM / FL (Floor)

Lampholder	W	Ilcos	*K	Optic	Colour	Class	Wiring	EEL =	Cosp ≥ 0,9	Code	Notes
PGJ5	20	MC		C	81	II	ETRC			04024181	
PGJ5	20	MC		C	94	II	ETRC			04024294	
PGJ5	20	MC		C	96	II	ETRC			04024396	

TYCO 11/21 SLIM / FL (Floor)

Lampholder	W	Ilcos	*K	Optic	Colour	Class	Wiring	EEL =	Cosp ≥ 0,9	Code	Notes
GX10	20	MR16			81	II	ETRC			04025481	
GX10	20	MR16			94	II	ETRC			04025594	
GX10	20	MR16			96	II	ETRC			04025696	

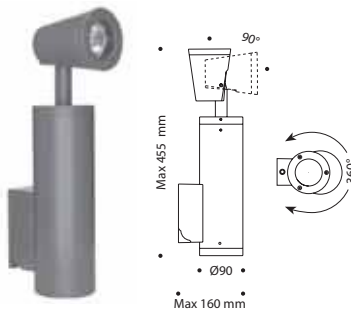

TYCO 11/20 SLIM / WL (Wall)

Lampholder	W	Ilcos	*K	Optic	Colour	Class	Wiring	EEL =	Cosp ≥ 0,9	Code	Notes
PGJ5	20	MC		C	81	II	ETRC			04025781	
PGJ5	20	MC		C	94	II	ETRC			04025894	
PGJ5	20	MC		C	96	II	ETRC			04025996	

TYCO 11/21 SLIM / WL (Wall)

Lampholder	W	Ilcos	*K	Optic	Colour	Class	Wiring	EEL =	Cosp ≥ 0,9	Code	Notes
GX10	20	MR16			81	II	ETRC			04026081	
GX10	20	MR16			94	II	ETRC			04026194	
GX10	20	MR16			96	II	ETRC			04026296	

			11 MT IK 07 2J max 1,2 kg	11 SLIM FL/WL IK 08 6J max 2,1 kg	11 RM IK 07 2J max 0,83 kg	BOX 11 RM IK 09 18J max 1,83 kg		
--	--	--	------------------------------------	--	-------------------------------------	--	--	--

only for 11/MT	CLASS I	CLASS II	81	94	96					IP 66		MC 20W CDM-TM		MR16 20W CMH-MR16
----------------	---------	----------	----	----	----	--	--	--	--	-------	--	---------------------	--	-------------------------

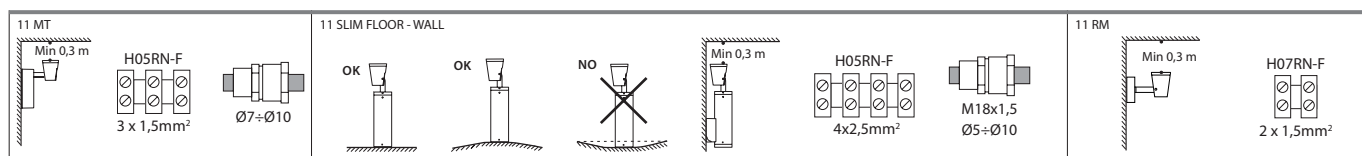

TYCO 11/20 RM

Lampholder	W	Ilcos	*K	Optic	Colour	Class	Wiring	EEl =	Cosp ≥ 0,9	Code	Notes
PGJ5	20	MC		C	81	II				01043581	!1
PGJ5	20	MC		C	94	II				01043694	!1
PGJ5	20	MC		C	96	II				01043796	!1

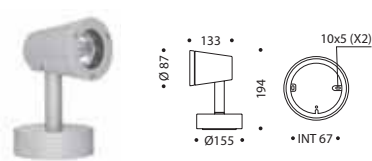

TYCO 11/21 RM

Lampholder	W	Ilcos	*K	Optic	Colour	Class	Wiring	EEl =	Cosp ≥ 0,9	Code	Notes
GX10	20	MR16			81	II				01044781	!2
GX10	20	MR16			94	II				01044894	!2
GX10	20	MR16			96	II				01044996	!2

!1 Control gear available in remote box TYCO11/20 RM

!2 Control gear available in remote box TYCO11/21 RM

BOX TYCO 11/20 RM Complete with 2m of cable H07RN8-F

W	Colour	Class	Wiring	EEl =	Cosp ≥ 0,9	Code
20	81	II	ETRC			14092581
20	94	II	ETRC			14094194
20	96	II	ETRC			14094296

BOX TYCO 11/21 RM Complete with 2m of cable H07RN8-F

W	Colour	Class	Wiring	EEl =	Cosp ≥ 0,9	Code
20	81	II	ETRC			14094381
20	94	II	ETRC			14094494
20	96	II	ETRC			14094596

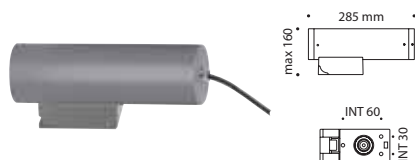

ACCESSORIES

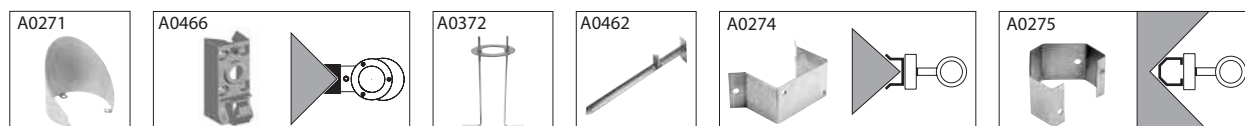

Code	Denomination	Colour	Description
14048381	A0271	81	External aluminium cowl finished powder coated black
14037894	A0271	94	External aluminium cowl finished powder painted aluminium grey.
14096296	A0271	96	External aluminium cowl finished powder coated.
14038404	A0274	04	AISI 304 stainless steel bracket for external 90° corner mounting (only for TYCO 11 RM).
14038504	A0275	04	AISI 304 stainless steel bracket for internal 90° corner mounting (only for rTYCO 11 RM).
14094681	A0466	81	90 °Angle wall bracket TYCO 11 SLIM/FL black.
14094794	A0466	94	90 °Angle wall bracket TYCO 11 SLIM painted aluminium grey.
14094896	A0466	96	90 °Angle wall bracket TYCO 11 SLIM grey.
14071320	A0372		Anchor rods for in-ground concrete mounting stainless steel plate with galvanised steel rods (TYCO11 SLIM/FL only).
14092202	A0462		Galvanised steel ground mounting spike (TYCO11 SLIM/FL only)
14093920	A0464		20W CDM-TM electronic ballast mounted on galvanised steel gear tray supplied with 2M cable. - IP20 class I -
14094020	A0465		20W CMH-MR16 electronic ballast mounted on galvanised steel gear tray supplied with 2M cable. - IP20 class I -